

# Kensington®

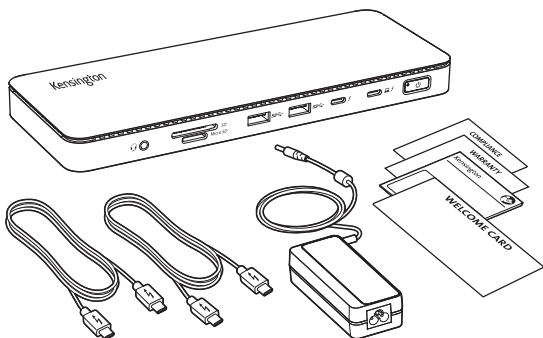

## SD5768T EQ Thunderbolt™ 4 dock with Thunderbolt™ Share



**US**



**EU**



**UK**



**AU/CN**



**JP**



[kensington.com/register](https://kensington.com/register)

1

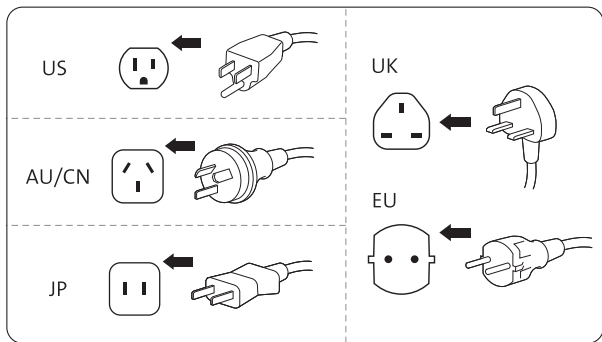
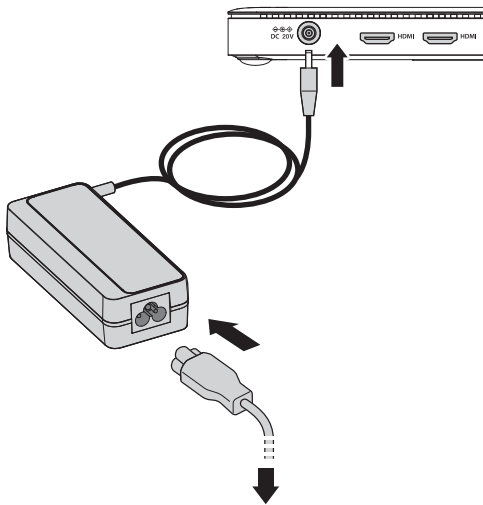

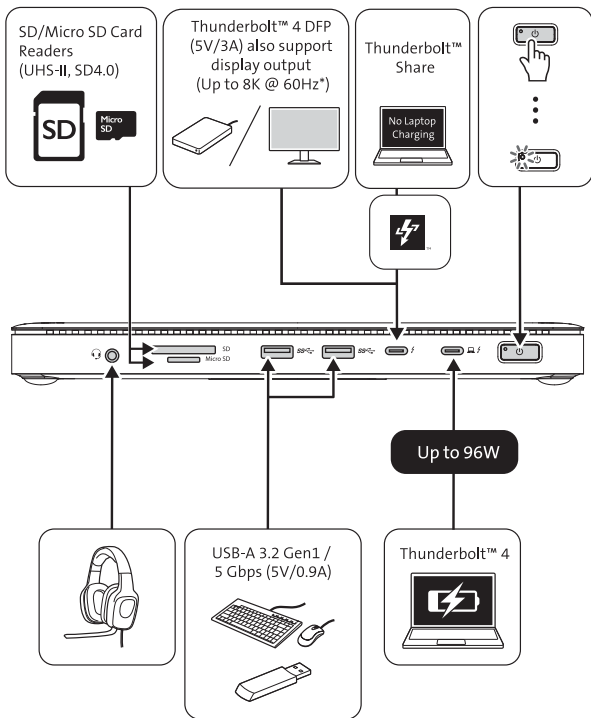

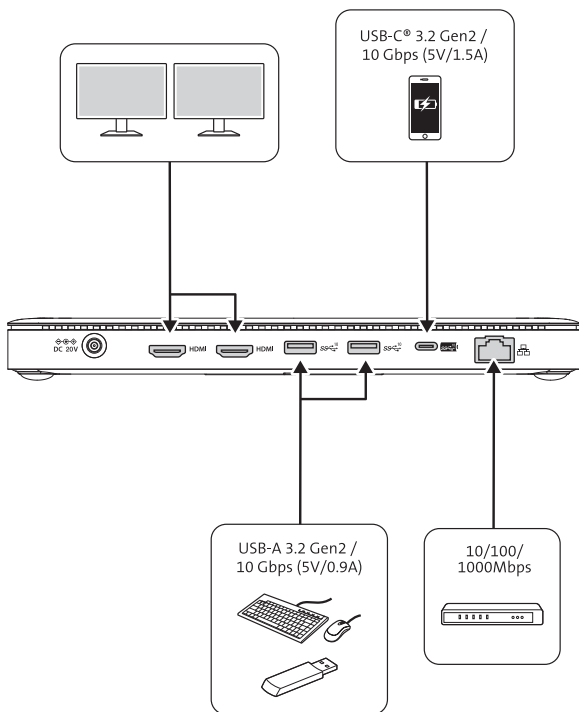

**3 a**

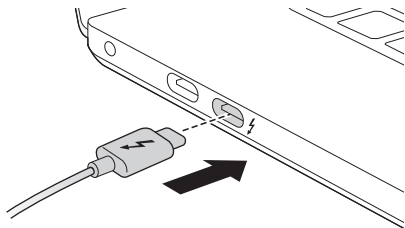
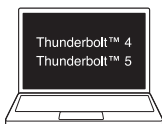

**4 a**

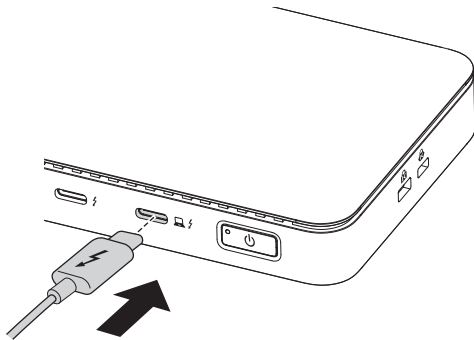

**3** **b**



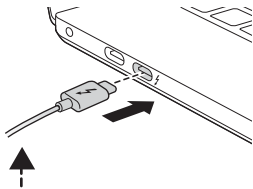
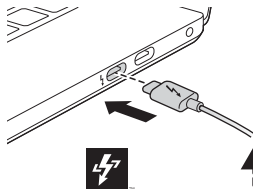
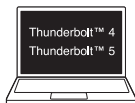
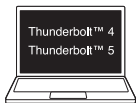

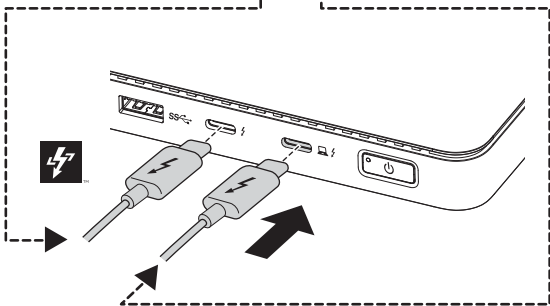

Thunderbolt™ Share









**4** **b**



# 5

				
		 HDMI	 HDMI	 HDMI
<b>Thunderbolt™ 4</b> <b>Thunderbolt™ 5</b>	<b>8K @ 60Hz*</b>	<b>4K @ 60Hz</b>	<b>4K @ 60Hz</b>	

				
		 HDMI	 HDMI	 HDMI
<b>Thunderbolt™ 4</b> <b>Thunderbolt™ 5</b>	<b>4K up to 120Hz*</b> or <b>1080p up to 240Hz</b>	<b>1080p</b> <b>up to 240Hz</b>	<b>1080p up to 240Hz</b>	

\* Support for Display Stream Compression (DSC) is based on the host device and monitor capabilities.

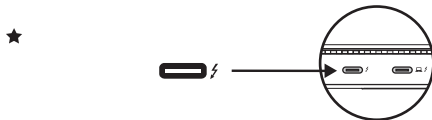

# Thunderbolt™ Share Guide



Visit  
**[kensington.com/SD5768T](https://kensington.com/SD5768T)**  
to download and install Thunderbolt™ Share Software

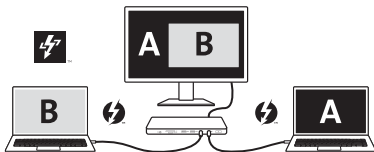



**Sold separately**

**1**

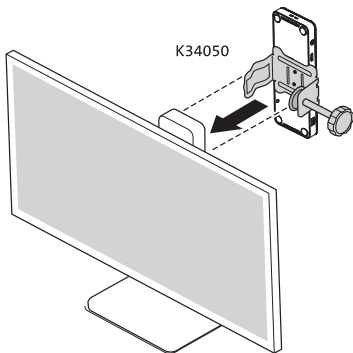

**2**

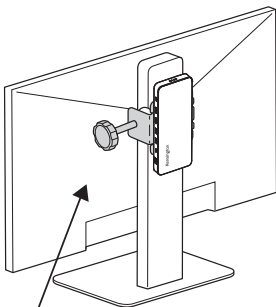

**< = 13.2lbs  
( < = 6.0kg )**

**Sold separately**

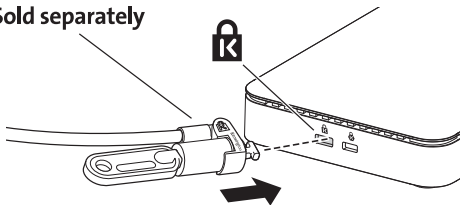

Recommended  
K65020WW MicroSaver® 2.0 Keyed Lock

**Sold separately**

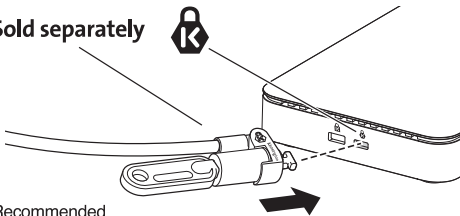

Recommended  
K65021WW Slim NanoSaver® 2.0 Keyed Laptop Lock

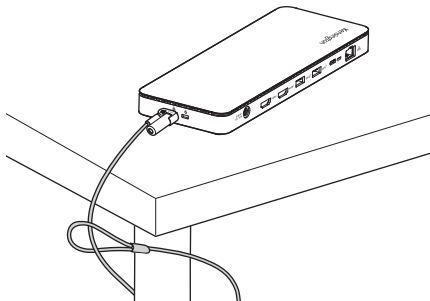



[www.kensington.com/support](http://www.kensington.com/support)

Kensington® is a registered trademark of ACCO Brands. Thunderbolt™ and the Thunderbolt™ logo are trademarks of Intel Corporation in the U.S. and/or other countries. Windows is a registered trademark of Microsoft Corporation in the U.S. and/or other countries. USB-C® is a trademark of USB Implementers Forum. All other registered and unregistered trademarks are the property of their respective owners.

© 2024 Kensington Computer Products Group, a division of ACCO Brands.

Patents: <https://www.accobrand.com/patents/>



K35381

901-7475-00